



**RANTEX**  
siden 1965

Tekmar 2010

Avlusning med helpresenning –  
umulig eller en  
«En vanlig dag på jobben».

Daglig leder Svein Tveiten

Rantex as

**AVLUSNINGSPRESENNINGER**

**LYSSTYRINGSTELT**

**STILLASPRESENNING**

**RANTEX**  
siden 1965

**RANTEX**  
FLAARØNNING  
SIDEN 1865

**INDUSTRI TEKSTILER**

**SKREDDERSØM**

**SALMAKER**

**RANTEX**  
siden 1965

**RANTEX**  
siden 1965

**RANTEX**  
siden 1965

**RANTEX**  
siden 1965

**RANTEX**  
siden 1965

Mo i Rana

**RANTEX**  
FLAARØNNING  
SIDEN 1865

Trondheim, Ler

**RANTEX**  
siden 1965

**RANTEX**  
siden 1965

**RANTEX**  
siden 1965

**RANTEX**  
siden 1965

**RANTEX**  
siden 1965

**RANTEX**  
siden 1965

RANTEX  
siden 1965

RANTEX  
siden 1965

RANTEX  
siden 1965

RANTEX  
siden 1965

# Topilouse

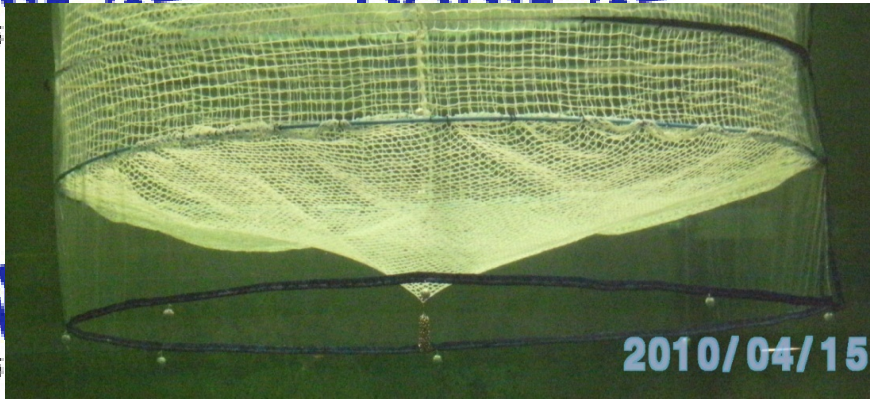

RANTEX  
siden 1965  
April 2010

RANTEX  
siden 1965

RANTEX  
siden 1965

RANTEX  
siden 1965

Desember 2010



RANTEX  
siden 1965



RANTEX  
siden 1965

RANTEX  
siden 1965

RANTEX  
siden 1965

RANTEX  
siden 1965

RANTEX  
siden 1965

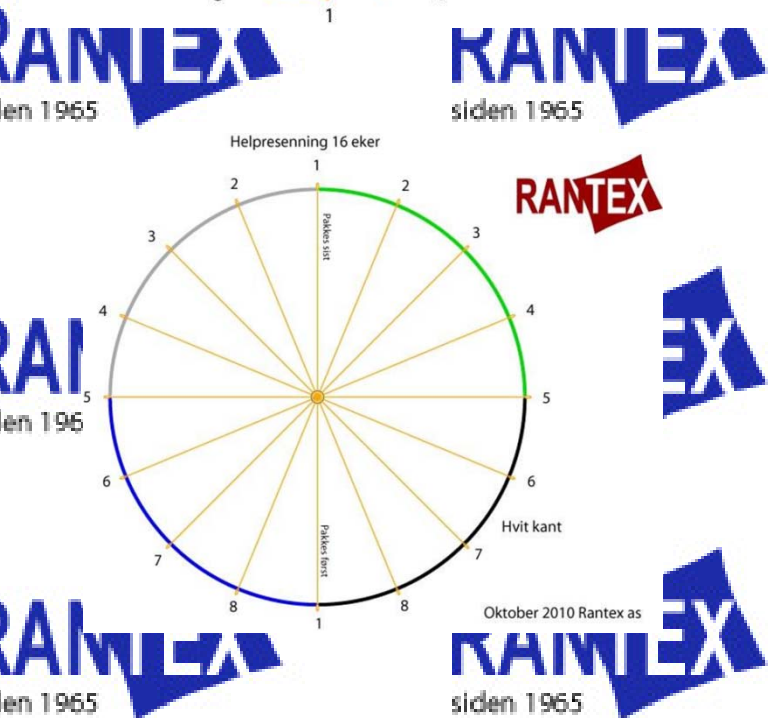
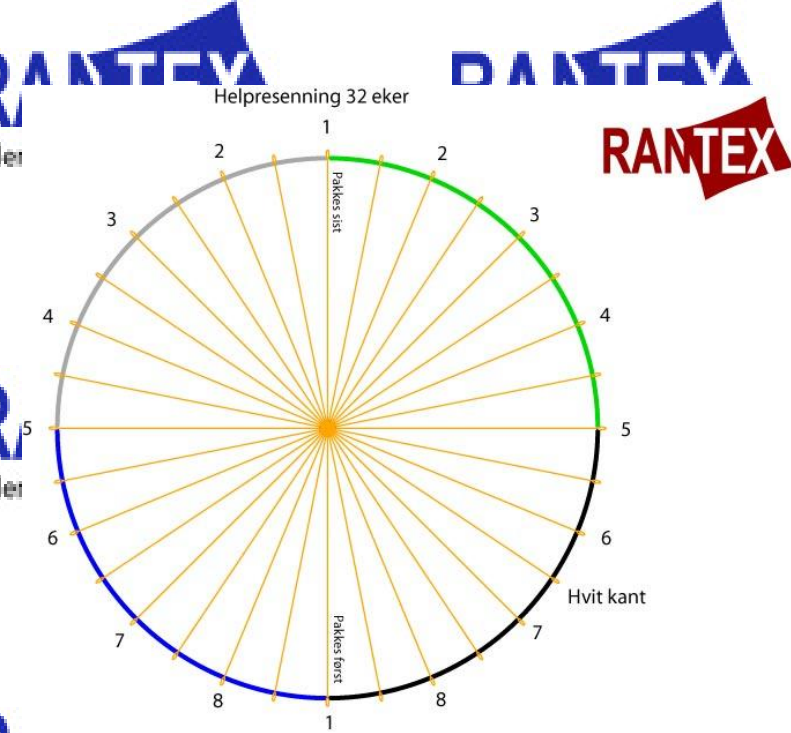

**RANTEX**  
siden 1965

**RANTEX**  
siden 1965

## Basisutstyr

- Merde 160m – presenning Ø 66m
  - Anbefalt 32 stropper
  - Evt oppdriftspølse 2x85m
- Merde 120m – presenning Ø 55m
  - Anbefalt 16/32
  - Evt oppdriftspølse 2x70m
- Merde 90m – presenning Ø 45m
  - Anbefalt 16 stropper
  - Evt oppdriftspølse ?

## Tillegg obligatorisk utstyr

- 2-3 uavhengige Netox 15x15m el. tilsv
- Pumpe til medisin 100-200l/min
- 2 stk 45m 50mm perforert brannslange
- 250 kg lodd til utsetting
- Evt 2-4m<sup>3</sup> kompressor for oppdrift

# Firkant

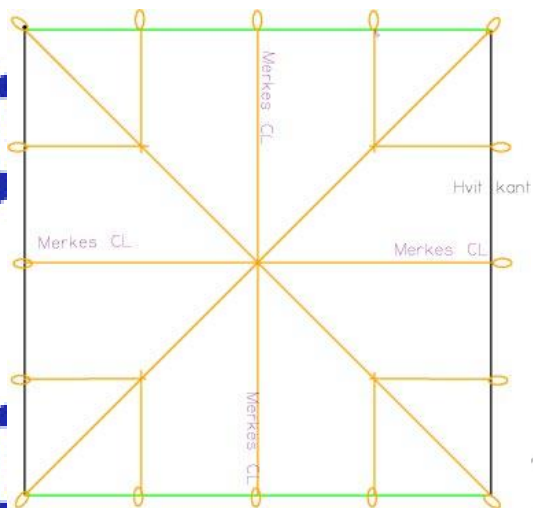

# Skuff

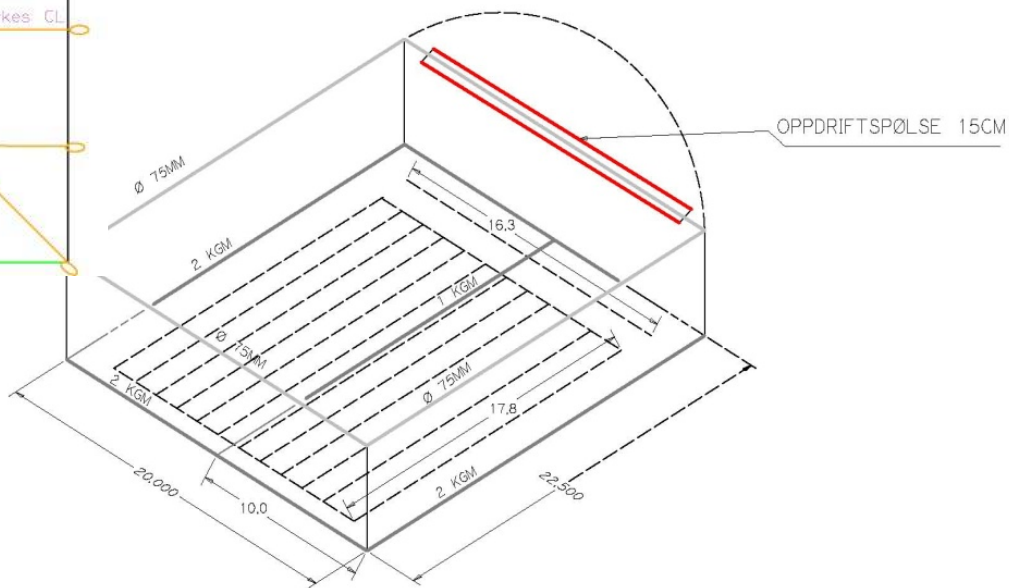



Tekstil



Tekstil ca 350kg/5cm

Bånd bruddlast 5.000kg/5cm

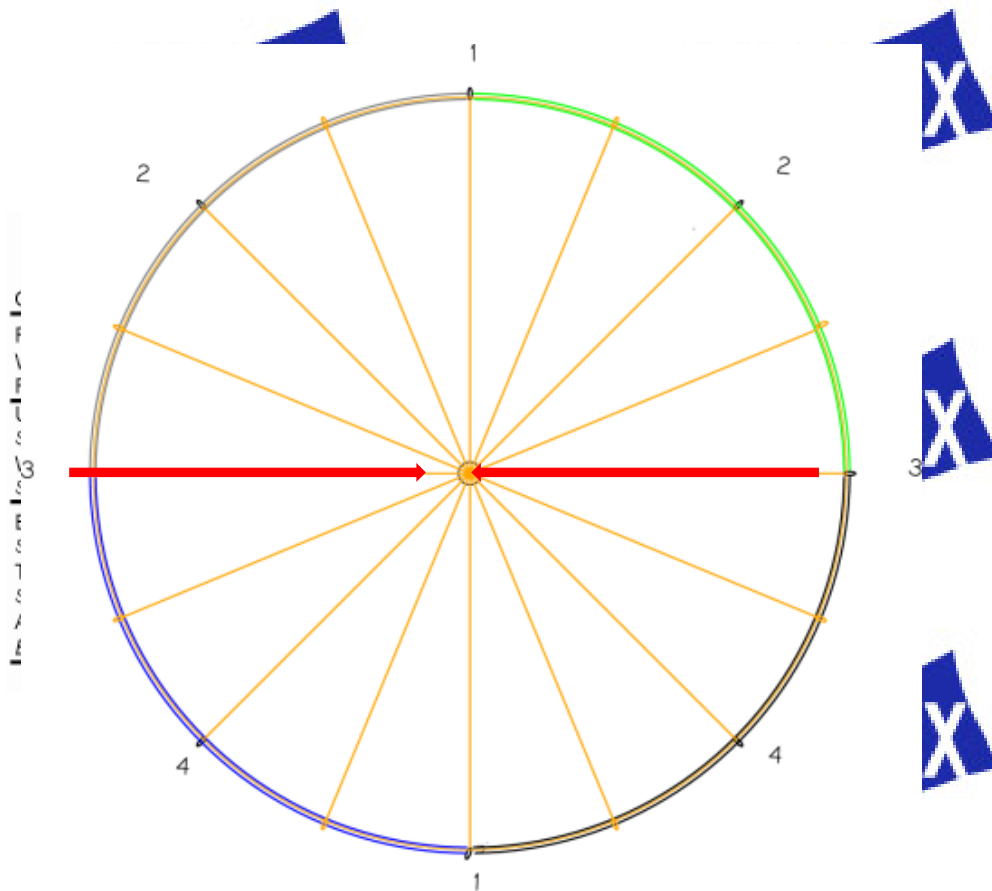

# Praktisk avlusning med og uten bunnring



Line opp not til 5m



Løfte bunnring til ca 6m.  
Uten bunnring må loddene heves.



- Løfting av dødfiskhåv
- Løfting av kjele
- Utsetting Netox/oksygen
- Medikamentslanger

# Plassering av tau

en 1965

en 1965

en 1965

en 1965

en 1965

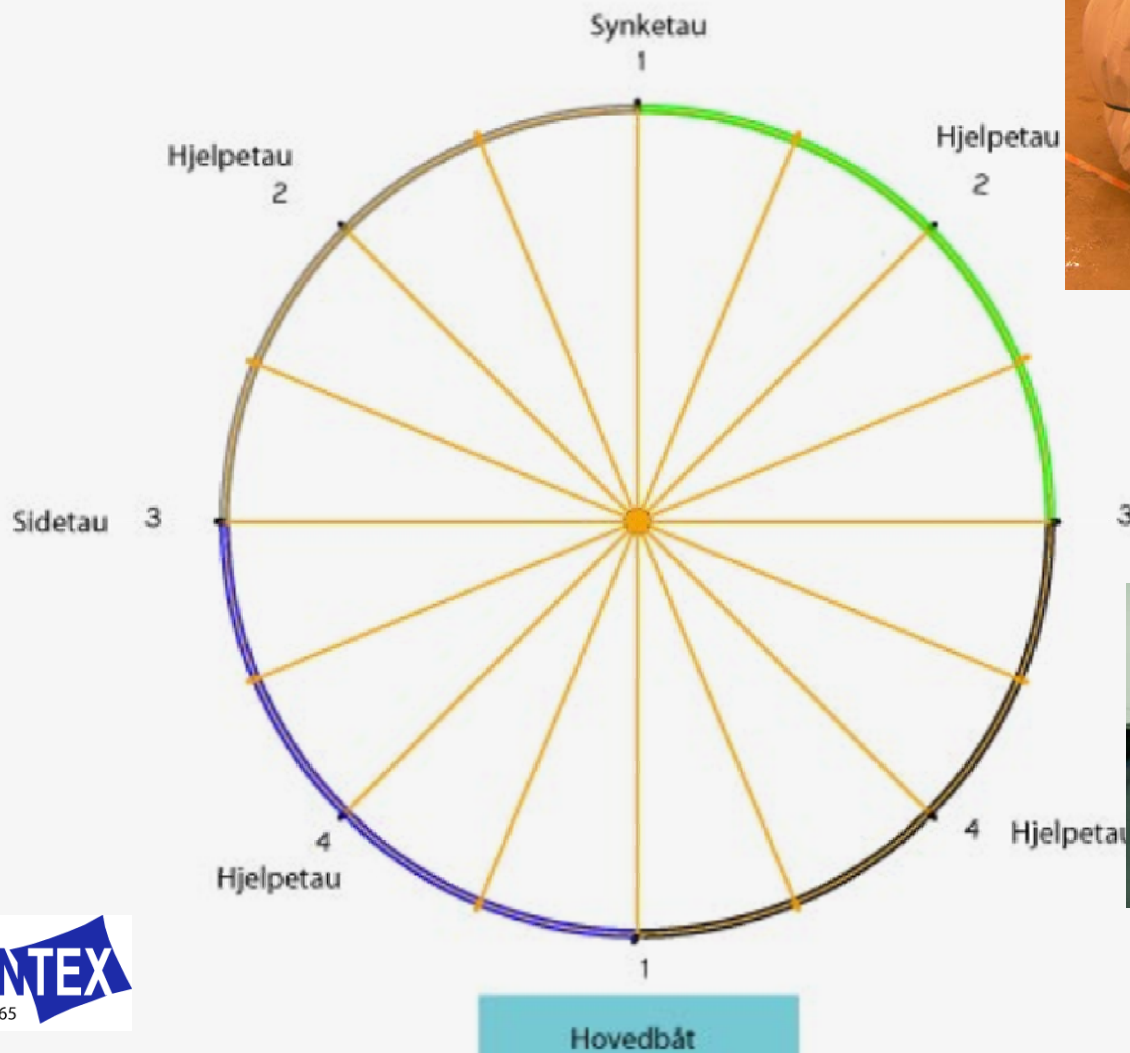

3 Sidetau



4 Hjelpetau

**RANTEX**  
siden 1965

siden 1965

siden 1965

siden 1965

EX  
EX  
EX  
EX  
EX  
EX



# Utgång av synketau

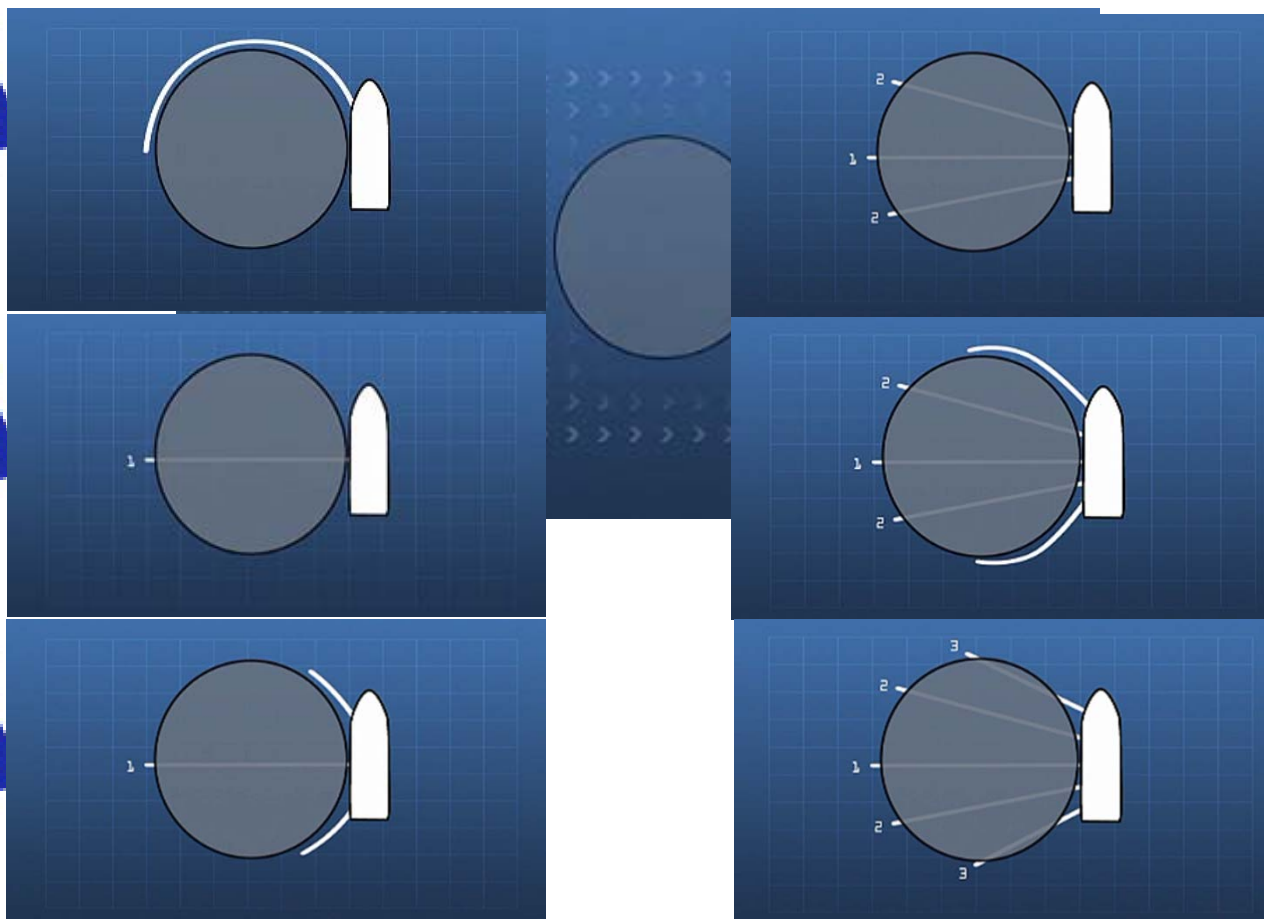

# Prinsippskisse

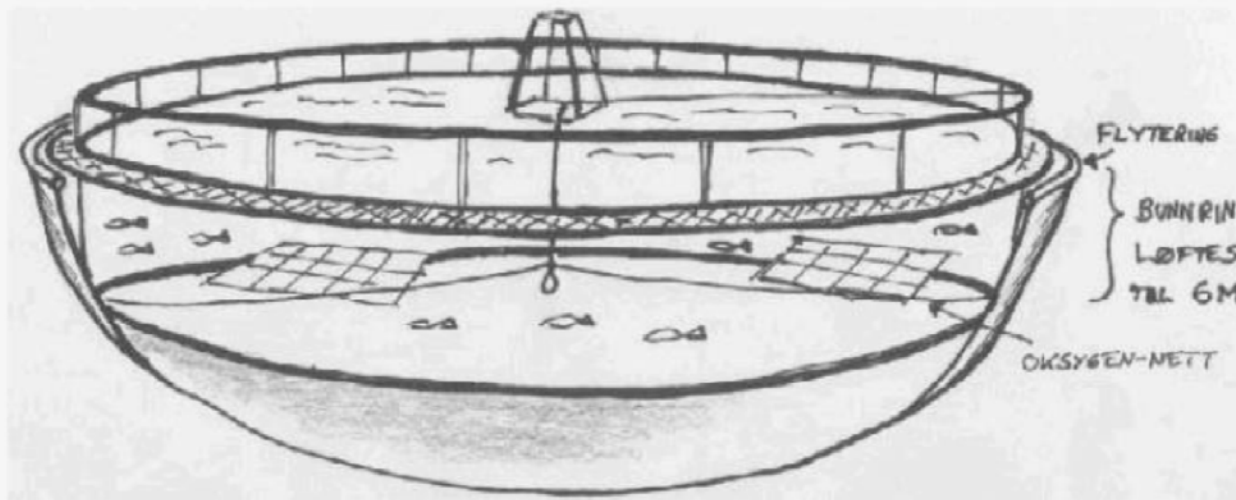



## Ressursbruk



- 3 timer med 9-10 pers og 4 båter
- Med oppdriftspølse, 3 timer med 5-6 pers og 2 båter



# Oppdriftspølse

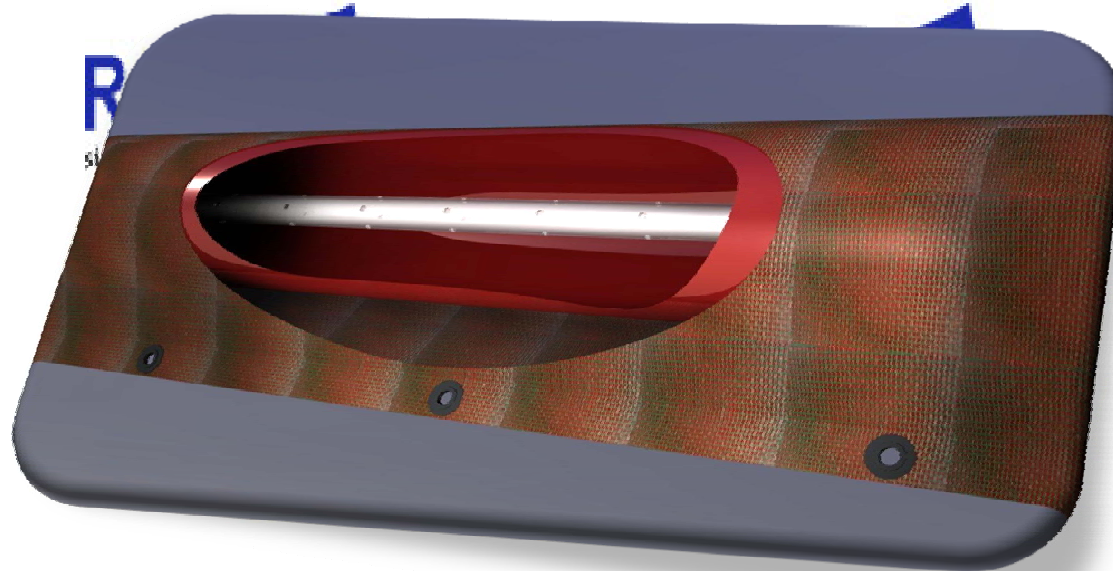

Reduserer ressursbehovet

### Trinn 1 - utsetting



### Trinn 2 - heving

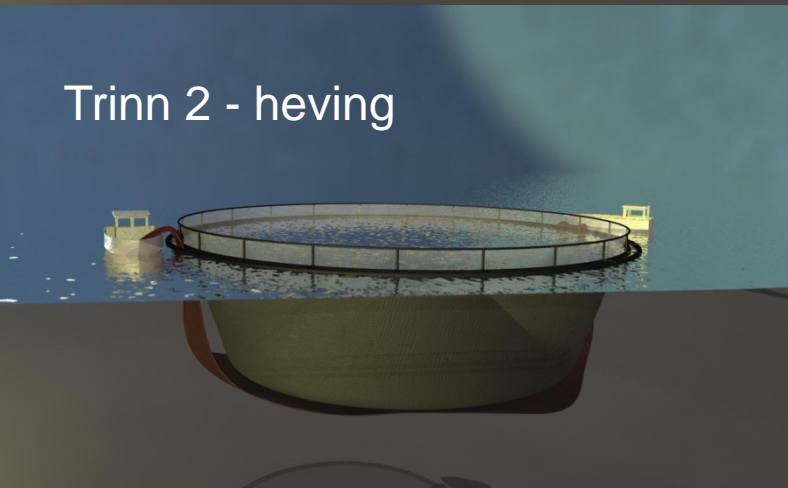

### Trinn 3 - avlusing

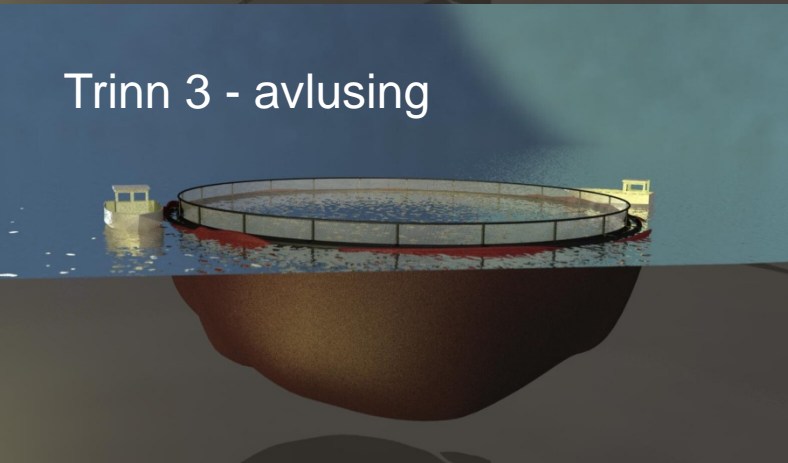

Helpresenning med oppdrift.

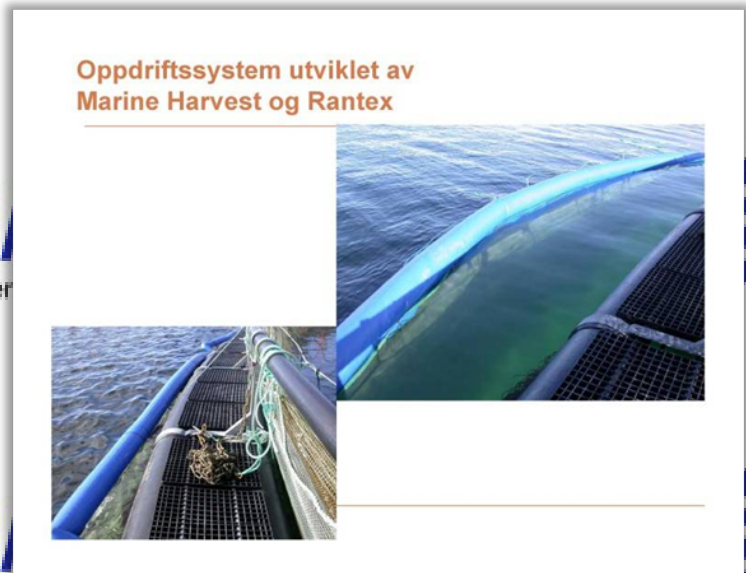

- «Det normale er 0 stk dødfisk etter behandling med helpresenning»

Kjøre inn  
propellsjø

- **Propellsjø** i 10 minutt inn i nota etter beh.
- Bruk stor båt (40 fot katamaran el tilsv. og ikke påhengsmotor).
- Da kan man dosere «tøffere»,
- Holde lengre og få max effekt uten fare for fisken.



Alt i motsatt rekkefølge



# Fordeler helpresenning

- Mindre stress på fisk
- Kostnadseffektivt
- 4-5 160m på en god lang dag
- Raskt
- Bruke egne ressurser
- Tilnærmet 0 dødlighet
- Slettes ikke vanskelig!!
- Nyttig sosial happening på lokaliteten



## Utfordringer/begrensninger

- Ikke sette i gang uten erfaring/befaring
- Opplæring og nok kvalifisert personell
- Rett oppsatt oksygenutstyr
- Vær og strøm
- Volumberegning
- Max 700t biomasse opptil 15 °C
- Har vi nådd grensen mht størrelse?
- Fasongsydd presenning?
- Hydrogenperoksyd i merde?

## Forbedring av metode

- Trommel eller Triplex til presenningen
- Enklere metode for heving av bunnring/lodd
- Ta i bruk stavtauene for opplining
- Egne spesialiserte lag
- Sensorer på ulike steder i badet for å overvåke

# Verdikjeden

- Del av en verdikjede
- Ryddighet i forhold til offentlige myndigheter
- Norskprodusert
- Utviklet sammen med oppdrettere
- Lange relasjoner til kunde/leverandører
- «Stein på stein»



**Takk for  
oppmerksomheten!**